



Congratulations on the purchase of your new BrakeAway Motorcycle Cruise Control. At BrakeAway Products, we are committed to your complete satisfaction. With proper installation, use, and periodic maintenance, this cruise control is built for the long haul in more ways than one. Please follow all of the instructions carefully to insure your riding safety and enjoyment.

PROPER USE,

(The following information is to be shared with any person who will be riding or buying any Motorcycle equipped with a BrakeAway Cruise Control).

Always include your cruise control in your standard pre-ride inspection. Make sure the unit engages easily, throttle should turn with little effort but remain in position on its own. The unit should effortlessly snap to the disengaged position with a slight pull of the brake lever or tap of the Manual Release Lever. The throttle should always turn freely when unit is disengaged. Check the cam (see diagram on next page) for wear at the point of contact with the brake lever or damage of any kind. All fasteners must be tight.

Warning! Never use this product with worn or damaged parts. All replacement parts are obtainable by contacting BrakeAway Products Inc at (503)372-9346 or e-mail customersevice@brakeawayproducts.com.

Once you're on the open road and ready to cruise, reach the speed you want to maintain and let your R.P.M.s level off. While holding the throttle still, reach with your right thumb only and push the engage button until it snaps. The BrakeAway will now hold this throttle position for you. You can make adjustments for up or downhill grades with a slight twist of the throttle while engaged.

To disengage the unit simply pull the front brake or push forward on the manual release lever with your right thumb until the unit snaps to the disengaged position. Always keep your cruise control clean and free of debris, occasionally lubricate the catch pin with WD40 or chain wax.

Never forget that you maintain control even when unit is engaged. Always be aware of your cruising speed and maintain safe distance from objects or vehicles in front of you. Never let go of your throttle. The BrakeAway cruise control is not intended for hands free or one handed riding, this unit was specifically designed to allow the rider to safely rest a cramping throttle hand on the throttle.

BrakeAway Products Inc. wishes you many years of cramp free cruising, ENJOY and ride SAFELY!!!

6CP05

Parts Diagram

Top View

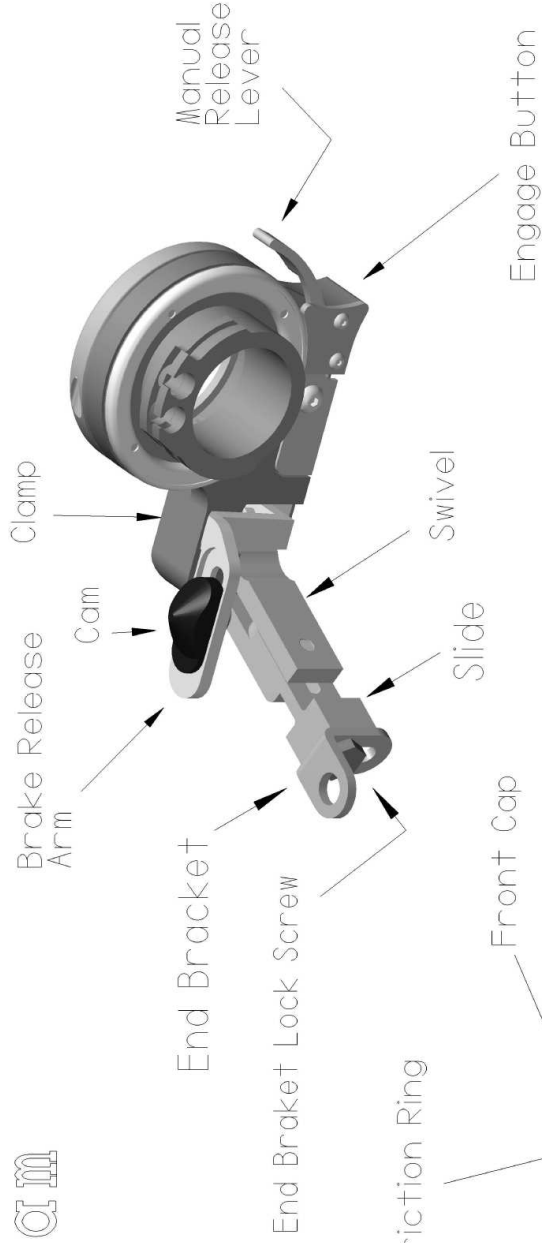

Cap Screws (2)

Drive Pin

Friction Ring

Front Cap

Back Cap

Manual Release Lever

Clamp Tension Screws (2)

Spring Plate

Catch Pin

Swivel Lock Screw

Slide Lock Screw

Threaded Brake Pivot Pin

1/8" Allen

Bottom View

End Bracket

6CP05 BrakeAway Motorcycle Cruise Control Installation Instructions

Before you begin, check the action of your throttle return spring by turning your throttle and quickly releasing it. If the friction screw on the bottom of your switch housing is not tightened down and your cables are in proper working order, your throttle should snap back to idle position. Please correct any problems with the friction screw or throttle cables before installation of cruise control. **Make a mental note of how your throttle snaps back so you have a reference at the end of the installation.**

All references to **Front** refers to the **Front (headlight end)** **Back** refers to the **Back (taillight end)** of the Motorcycle.

Section 1 Preparation and Disassembly

- 1.a If your bike is not fuel injected, turn off the fuel supply before you begin.
- 1.b **C clip type pin retainer** If there is a C Clip retainer on the bottom of your brake pivot pin, remove the C clip (*Image 1*). Do not remove the pin yet. Compare the **C clip** to the two threaded brake pivot pins supplied in your kit. Select the pin that fits your C clip and set it within arms reach and proceed to 1.d
- 1.c **Nut type pin retainer** If there is a nut on the bottom of your brake pivot pin, remove the nut and set it aside, you will need to replace the nut later in the installation. Do Not remove the pin. Skip over step 1.d
Note: Follow all references to **Nut type pin retainer** in the remaining instructions.
- 1.d While carefully holding the brake lever in place, remove the stock brake pivot pin (*Image 2*). Install the appropriate replacement pin (*Image 3*). Re-install the C clip onto the new replacement pin.

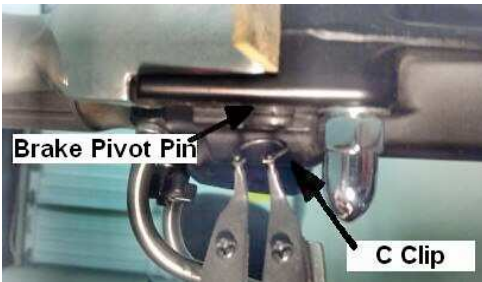

Image 1 Ref 1.b



Image 2 Ref 1.d



Image 3 Ref 1.d

- 1.e Pull the brake lever and insert a wood shim or piece of cardboard into the gap shown. (*Image 4*). This will hold the brake lever slightly closed to prevent damage to the brake light plunger switch during the disassembly and assembly of the switch housing.
- 1.f Slide the two rubber boots down the throttle cables to expose the cable adjusters (*Image 5*). Measure the length of threads showing on each cable (*Image 6*). Make a note of each length so you can return them to the same positions during the installation of the cruise control.
The 3/8" length in image 6 is just an example. Make a note of the actual thread lengths on your cables.

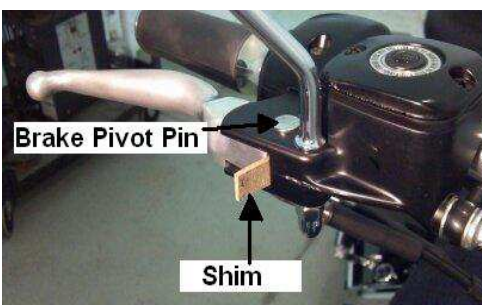

Image 4 Ref 1.e

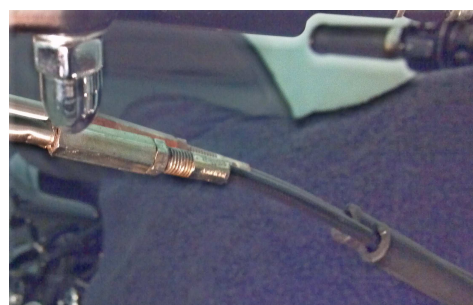

Image 5 Ref 1.f

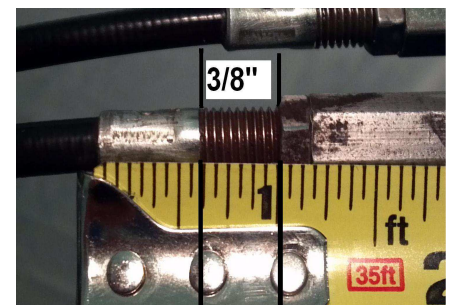

Image 6 Ref 1.f

- 1.g** Use two 3/8" wrenches to loosen the cable adjuster jam nuts (**Image 7**). Run the nuts all the way down to the end of the threads followed by the cable adjusters (**Image 8**).
- 1.h** Loosen the Harley star screw. (*bottom of the switch housing between the cables*). Turn it down counterclockwise a few turns. This screw will no longer be needed but there is no need to remove it. Remove the upper and lower switch housing screws (T-25 Torx) (**image 9**) to separate housing.

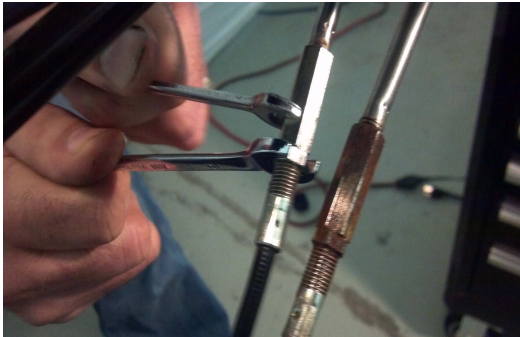

Image 7 Ref 1.g



Image 8 Ref 1.g



Image 9 Ref 1.h

- 1.i** Tie the upper half of the switch housing to the mirror post to keep it out of the way. Turn the throttle back so you can unhook the rear cable from the throttle grip. Hold onto the brass ferrule as you pull the cable off (**Image 10**) and then carefully remove the ferrule from the cable (**Image 11**).

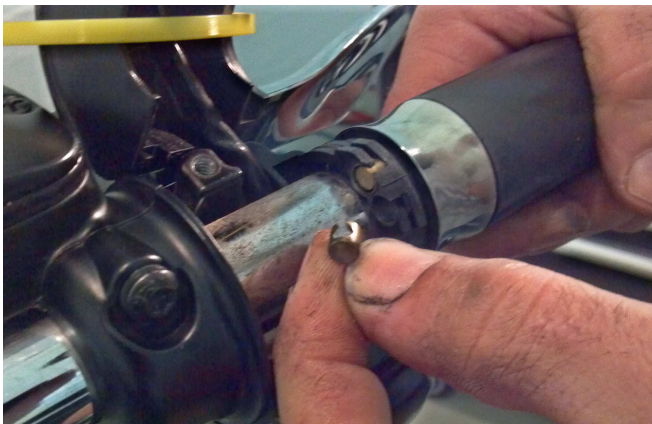

Image 10 Ref 1.i

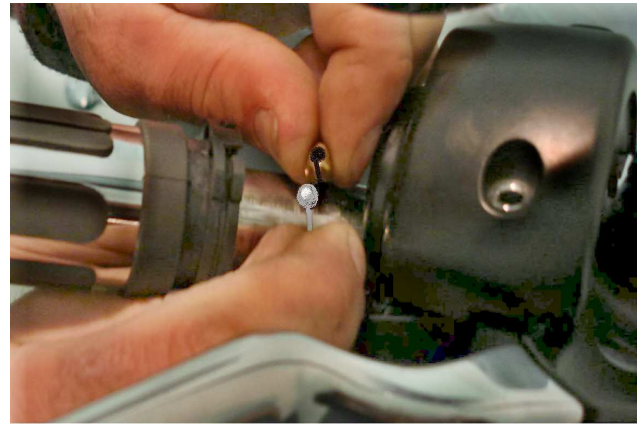

Image 11 Ref 1.i

- 1.j** Place a small flathead screwdriver under the front cable and pull the cable up as you rotate the throttle towards idle position (**Image 12**). Remove the cable and ferrule and slide the throttle grip off of the handlebar (**Image 13**).



Image 12 Ref 1.j



Image 13 Ref 1.j

Inspect cables! Replace any frayed, worn or damaged cables at this time.

Section 2 Grip Installation

2.a Remove the BrakeAway cruise control from the package. Disengage the unit by pushing on the manual release lever until the clamp pops open. (**See Parts Diagram for reference**). Rotate the friction ring to expose and remove the two cap screws (**Image 1**). Pull the front cap off as shown in the parts diagram. Rotate the ring and remove the back cap. (**Image 2**) shows both caps removed.

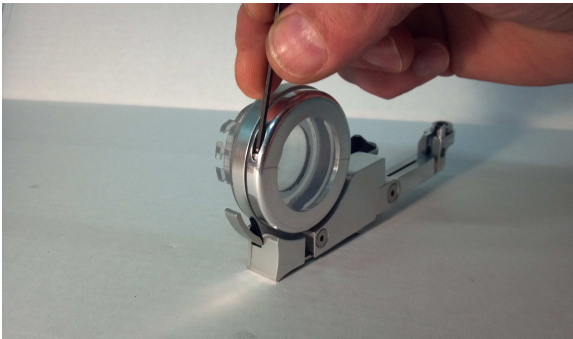

Image 1 Ref 2.a

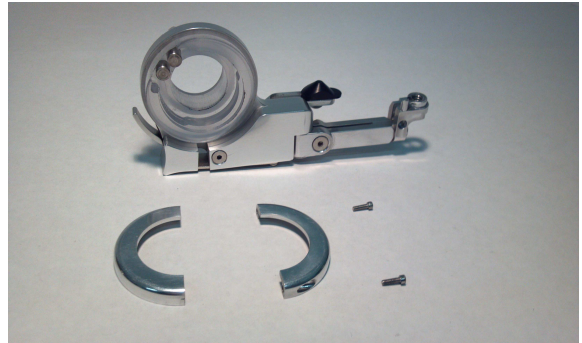

Image 2 Ref 2.a

2.b Remove the 1 3/8" O ring from your wrench bag and install it onto your throttle grip (**Images 3&4**). This will work as a spacer to keep the grip firmly mounted inside the friction ring. Line up the ferrule holes in your throttle grip with the two drive pins as shown (**Image 5**). Push the grip all the way into the friction ring pocket as far as it will go so the holes receive the two drive pins. Make sure the grip is all the way to the bottom of the pocket.



Image 3 Ref 2.b



Image 4 Ref 2.b

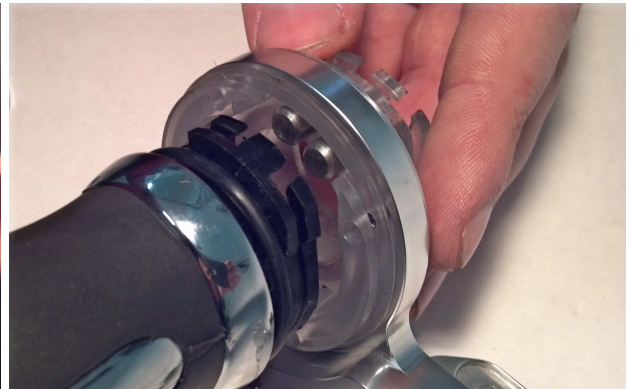

Image 5 Ref 2.b

2.c Use a small Allen wrench to push the O ring all the way into the groove in the friction ring. (**Image 6**). The O ring needs to be pushed in flush with the face of the friction ring all the way around.

2.d Turn the grip so the two drive pins are pointing away from the cruise control body. Slide the groove in the back cap (**threaded half, no thru holes**) so it mates with the groove in the friction ring and covers the O ring (**Image 7**). Push it all the way onto the friction ring as shown (**Image 8**).



Image 6 Ref 2.c

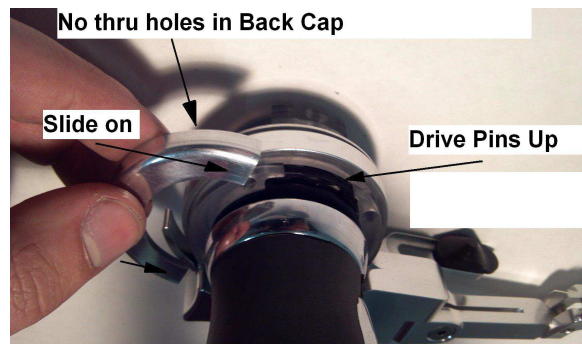

Image 7 Ref 2.d



Image 8 Ref 2.d

- 2.e Slide the front cap onto the friction ring until the ends of the two halves come together (**Image 9**). Re-install and tighten the two cap screws (**Image 10**). The grip end will now be trapped tight into the slip ring.

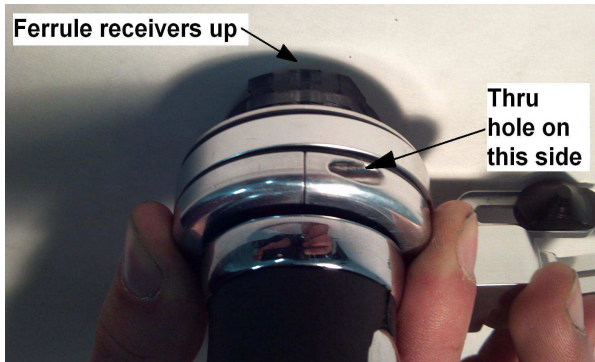

Image 9 Ref 2.e



Image 10 Ref 2.e

- 2.f Slide the entire assembly over the handlebar (**Image 11**). Replace the brass ferrule on the front cable and line it up with the front receiver hole in the friction ring. Place a small flathead screwdriver to lift the cable up while holding the ferrule in place (**Images 12&13**) Push the ferrule in and lay the cable in the center slot as shown in (**Image 14**). Re-install the back cable (**Image 14**).



Image 11 Ref 2.f

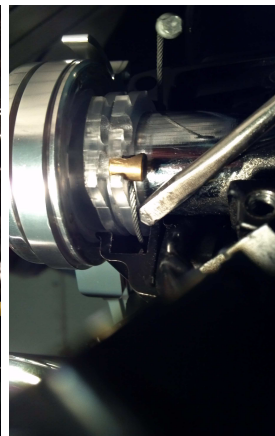

Image 12
Ref 2.f

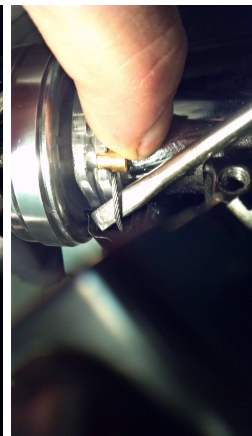

Image 13
Ref 2.f



Image 14
Ref 2.f

- 2.g Return both cable adjusters back to their original positions and tighten the jam nuts. (**Image 15**) Refer to your measurements taken in step 1.5. Slide the rubber boots back over the adjuster nuts.

- 2.h Re-Assemble the upper and lower switch housing (T-25 Torx) (**Image 16**).

- 2.i Remove the shim from your brake lever at this time (**Image 17**). Do not proceed to the next step with shim in place or your brake release cam will be set to an incorrect position!

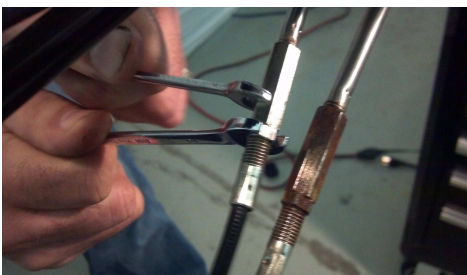

Image 15 Ref 2.g



Image 16 Ref 2.h



Image 17 Ref 2.i

SECTION 3: CAM ADJUSTMENT AND FINAL ASSEMBLY

- 3.a** Rotate the clamp until the cam support is positioned close to but not touching the bottom of the motorcycle brake lever. Carefully squeeze the clamp together as shown (*Image 1*) until it snaps into the engaged position. You should always hear and feel a positive snap when the unit engages. **Do not allow the cam or cam support to push up against the brake lever during this step. This will stop the unit from engaging properly and could bend the spring plate.**
- 3.b** Rotate the throttle along with the **engaged** unit so the cam support is about 1/8" under the bottom of the brake lever. Slide the cam against the back of the brake lever so the bill of the cam slides under the brake lever (*Image 2*). Tighten the bottom side cam screw with lock washer to retain this cam position.



Image 1 Ref 3.a



Image 2 Ref 3.b

- 3.c** **Nut type retainer pin only** Attach the end bracket to the bottom of the threaded brake pivot pin as shown in (*Image 3*). You will not need the Allen wrench. Use the nut that you removed earlier in the instructions to attach the end bracket but just snug the screw **Do Not tighten all the way yet!** Proceed to step 3.e
- 3.d** **C Clip type retainer pin** Make sure you have already replaced the C Clip on the bottom of the new threaded brake pivot pin. Attach the end bracket to the threaded part of the new pin using the supplied lock nut Tighten the nut with the appropriate size open end wrench while using an Allen wrench in the end of the rod to hold the pin from turning (*Image 3*).
- 3.e** Release the cruise control to the off position by pushing the manual release lever forward (*Image 4*)

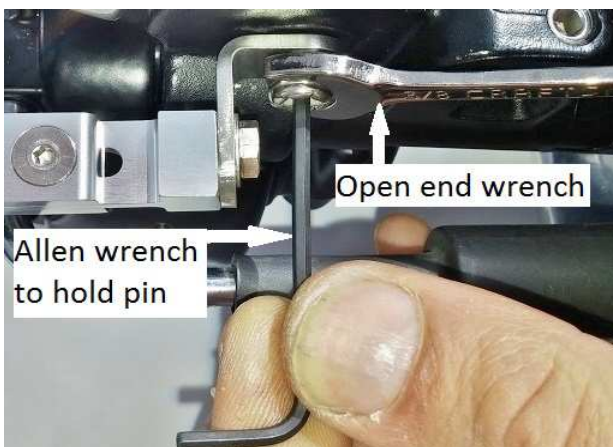

Image 3 Ref 3.c and 3.d



Image 4 Ref 3.e

IMPORTANT NOTE! Make sure the cruise control clears your tank! Before you continue, very slowly and carefully turn your front wheel all the way to the right. Watch the entire cruise control including the end bracket. Make sure that no part of the cruise control can make contact with your paint.

- 3.f With clamp in the disengaged or open position,** Pull the brake lever as to apply the front brake and hold it. Raise or lower the end bracket lock screw in the slot provided in the end bracket until the top of the cam just touches the bottom of the brake lever (*Image 5*).

Carefully hold the slide in this position and **slightly snug** the end bracket lock screw just enough to hold the slide in this position while you pick up a 1/2" open end wrench. Place the 1/2" wrench on the slide to keep it from turning as you **finish tightening** the end bracket lock screw (*Image 6*).



Image 5 Ref 3.f



Image 6 Ref 3.f

- 3.g** Hold the clamp so it stays straight and centered in the groove of the slip ring while you tighten the swivel lock screw (*Image 7*). Look over the top to make sure the clamp is resting straight in line with the slip ring after the screw is tight. If the clamp is not straight and centered in the groove, loosen the screw and try again until the clamp ends up straight in the groove with the screw tight.

- 3.h Nut type pin retainer only!** Finish tightening the brake pivot retainer nut at this time. Push back on the swivel with one hand as you tighten the nut with the other (*Image 8*). It is very important to keep the attached hardware from turning as you tighten this nut.

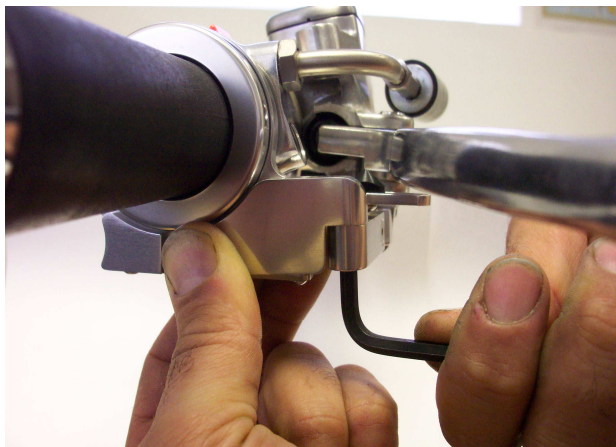

Image 7 Ref 3.g

Nut type pin retainer



Image 8 Ref 3.h

- 3.i** Engage and disengage the cruise control 3 or 4 times by squeezing the clamp together as shown (*Image 9*) and then releasing it with the manual release lever.

With the unit **disengaged**, turn the throttle and let go to check the operation of the throttle return. It should return to idle position normally. If the throttle does not return the same as it did before the installation, loosen the swivel lock screw and return to section **3.g**. The clamp is not straight enough.



Image 9 Ref 3.i

- 3.j Engage the cruise control as described in the last step. Tighten the slide lock screw (*Image 10*).
- 3.k Disengage the cruise control (*Image 11*)
- 3.l Turn the throttle and engage the cruise control by pushing forward on the engage button (*Image 12*). Be careful not to touch the manual release lever while engaging the cruise control. You should feel and hear a positive snap as the unit engages. Once **engaged**, turn the throttle back and fourth a few Times. The throttle should turn with moderate resistance and stay in position when you let go of it.



Image 10 Ref 3.j



Image 11 Ref 3.k
Disengage



Image 12 Ref. 3.l
Engage

Congratulations! your installation is complete. Please go through the testing and adjustment procedures to make sure the unit is working correctly and safely.

Testing:

- T.1 **Disengage your cruise control by pushing on the manual release lever. Turn your throttle and let go of it. The throttle should snap back to idle just as it did before the installation. If you are satisfied with the return action of your throttle, proceed to T.2.** If the throttle hesitates, check the Harley star wheel first, make sure it has been loosened and is not touching the cruise control. If the star wheel is not causing the problem, refer to #1 of the troubleshooting guide at the end of these instructions.
- T.2 **Turn the throttle and engage the cruise control by pushing forward on the engage button (see parts diagram) until the clamp snaps closed. Be careful not to touch the manual release lever during engagement. Make sure the spring plate is fully engaged with the catch pin by pushing up on the spring plate from the bottom. The plate should be all the way up. If it is, proceed to step T.3** If the cruise control does not close with a positive snap or if the plate moves up further when you push up on it, please check to make sure the cam is not hitting the brake lever during engagement. The cam should be directly behind the brake lever but not touching it when the cruise control is engaged. If the cam is hitting, move it back.
- T.3 **With the cruise control engaged the throttle should stay in place when you let go of it You can adjust the throttle position while engaged by simply turning it either direction. This is how you will adjust your speed as needed. The throttle should turn with a smooth resistance and stay where you put it. If it does, proceed to T.4** If the throttle slips or is too hard to move, please refer to section 4 for clamp tension adjustment.
- T.4 **Engage the cruise control and then apply the front brake while pulling upward on the brake lever. The cruise control should disengage without hesitation. After the unit is disengaged, apply the front brake while pushing down on the brake lever. The brake lever should just touch the top of the cam as it rides over it. If the unit hesitates before disengaging, check the cam position. It should be set directly behind the brake lever when the unit is engaged.**

Contact BrakeAway products at (techsupport@brakeawayproducts.com) or (503) 372-9346 if you are having problems with any of the last four steps. Do Not ride the motorcycle until all testing has been successfully completed and your cruise control is working as described.

Section 4: Clamp tension adjustment

Clamp Tension refers to the amount of friction or resistance that is applied to the throttle when the cruise control is engaged. You should always be able to turn your throttle with the unit engaged. The throttle should turn smoothly with just enough resistance to hold it in position while riding.

If your cruise control tension is too loose and will not hold reasonable throttle return spring tension, or if the factory setting ends up being too tight, carefully follow the instructions below.

4.a Fine tension adjustment

Your BrakeAway is equipped with a fine tension adjustment screw as shown (**Image 1**). This screw should be sufficient in most cases to loosen or tighten the clamp tension as needed. With the cruise control engaged, turn the screw clockwise **no more than 1/4 turn** to increase the clamp tension, counterclockwise to decrease it.

Turning the screw more than 1/4 turn can damage the clamp. If the fine tension adjustment screw does not tighten the clamp tension enough with 1/4 turn or if the screw comes loose in the hole while trying to loosen it. Loosen the fine tension screw, re-tighten it 1/4 turn and continue to section 4.B Main tension adjustment section 4.b below.

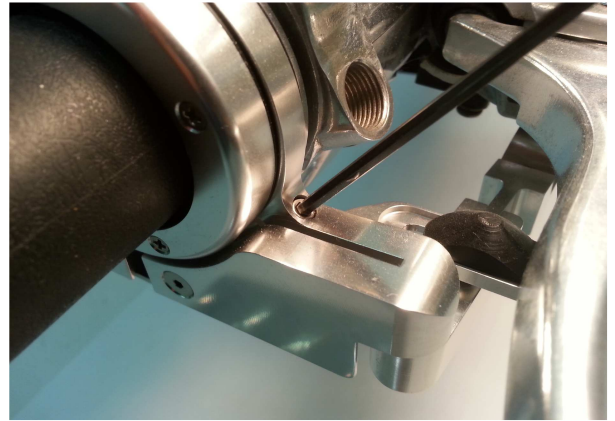

Image 1 Ref 4.a

4.b Main tension adjustment

With cruise control **engaged**, loosen and very lightly snug one tension retaining screw and then loosen and slightly snug the second screw. *These are the two Phillips head screws on the bottom of the cruise control just under the engage button (**Image 2**).* It is very important to do this one screw at a time. Make sure the catch pin remains fully engaged in the hole in the spring plate.

Insert the long side of a small Allen wrench into the tension adjustment hole. *This is the hole right between and just behind the two retaining screws.* Pull the bottom of the wrench back in a prying motion, toward the back of the bike to tighten, or push forward to loosen (**Image 3**) while turning the throttle to test the clamp tension. Stop as soon as the clamp will hold the throttle in place. The throttle should turn smoothly with moderate resistance. Tighten the two tension retaining screws. Now a 1/4 turn with your fine tension adjustment screw should be sufficient for any further adjustment required.



Image 2 Ref 4.b

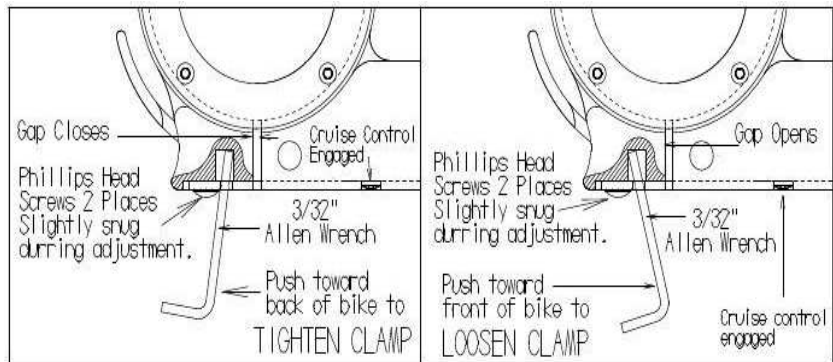

Image 3 Ref 4.b

Loosen and snug one screw at a time.

Pull Allen wrench back to tighten and forward to loosen tension.

Do not over-tighten the clamp tension. Over-tightening tension could cause throttle or brake release to malfunction.

SECTION 5: INSPECTION AND MAINTENANCE

- 5.a** Check your cruise control for proper operation during your pre-ride safety inspection. Make sure all components are tight and functioning properly. Check the cam for wear or damage of any kind.
- 5.b** Occasionally lubricate the catch pin with chain wax or WD-40; Annually remove the cruise control and wash it thoroughly with warm soapy water to remove road film and then dry thoroughly and re-lube the catch pin. Inspect the cam and all other components for wear or damage. Do Not use the BrakeAway cruise control with any worn, loose or damaged parts. All components are obtainable from BrakeAway Products Inc. (503)372-9346 or e-mail customerservice@brakeawayproducts.com

Trouble shooting

1. Problem: Throttle is binding with cruise control disengaged.

Cause: The clamp is positioned incorrectly so it is rubbing on the slip ring.

Solution: With cruise control disengaged, Please follow the instructions below in order until your throttle returns freely.

A. **Gently, slowly and very slightly** turn the slide with a 1/2" open end wrench, clockwise first then counter clockwise while checking the throttle return. Try to find a position where the throttle returns freely. If this works, then hold the slide with the 1/2" open end wrench and retighten the end bracket lock screw **See section 3.f**

B. Loosen the swivel lock screw and the slide lock screw. Hold the clamp so the clamp ring remains straight and in the center of the groove in the slip ring while you retighten the swivel lock screw. Retighten the slide lock screw.

C. **(Nut retainer type only)** Loosen and retighten the brake pivot nut. Hold the cruise control from turning when you tighten the nut. **See section 3.h**

2. Problem: Cruise control is hard to engage

Cause: The clamp tension is too tight or the clamp is positioned too far forward (toward the front of the bike)

Usually only happens on the nut retainer type pins because the end bracket turns when the brake pivot nut is tightened in section 3.h

Solution: Reposition the clamp slightly toward the back of the bike. This will free up some movement or travel in the push button. **To do this**, slowly turn the brake pivot nut as if to loosen it, watch the clamp as you turn the nut, at some point it should move toward the back of the bike. Stop as soon as you see it move. Retighten the brake pivot nut while holding the clamp from moving forward. Ref. Section 3.h. Your cruise control should now engage easily. If not, loosen the clamp tension **See section 4**

3. Problem: Cruise control will not stay engaged

Cause: The hole in the spring plate is not fully engaging onto the catch pin

There are three reasons why this might happen, see A,B,C respectively:

Reason A The cam or the cam support is hitting the brake lever during engagement.

Solution A Readjust the cam position or cam height so it does not make contact the brake lever during engagement. **See sections 3.b and/or 3.f**

Reason B The Clamp Tension is too tight. Your throttle should not be hard to move with cruise control engaged.

Solution B Adjust the clamp tension as described in section 4

Reason C The Spring Plate has been bent down away from the Catch Pin.

Solution C **Send the unit to us for repair (Call for RA#) or follow instruction below to straighten the Spring plate at the slots.** Remove the two clamp tension adjustment screws. The spring plate, cam support and cam will come down as an assembly. Place the slotted end of the spring plate down in a bench vise just to the end of the slots. The cam support pointing straight up and the cam pointing away from you. Push on the spring plate until you feel give just slightly. Reinstall the spring plate and readjust the clamp tension as described in section 4. If the bend is corrected, the cruise control will snap into engagement. If it is hard to release then the plate is bent too much.

Please contact BrakeAway Products tech support for additional assistance @ (503) 372-9346
or email techsupport@brakeawayproducts.com

“Important !!!” These instructions were designed as a guide line to install the BrakeAway Cruise Control. BrakeAway Products, Inc. assumes no responsibility for the competence level of the installer or the ability of the installer to determine the proper function of the BrakeAway Cruise Control. Proper installation, maintenance, and pre-ride inspection are essential to the safety of the BrakeAway Cruise Control, and are the sole responsibility of the installer and or user of the BrakeAway Cruise Control. If the installer and or user of the BrakeAway Cruise Control is unable to achieve function satisfactory to the user, or if the user is unable to maintain satisfactory function of the BrakeAway Cruise Control, it is the responsibility of the user to remove it or have it removed. You may return it to BrakeAway Products, Inc. under the terms of the warranty, within the warranty period.

Serious injury or death could result if the BrakeAway Cruise Control is installed improperly and or used irresponsibly. Hands free or one handed operation of a motorcycle is considered by BrakeAway Products Inc. to be dangerous and irresponsible and is not the intended function of this product.

Do Not install this product on any motorcycle which has not been tested and listed exclusively by BrakeAway Products Inc. for proper fit. See fit list on the back of package or at www.brakeawayproducts.com
BrakeAway Products, Inc. along with all authorized dealers assume no responsibility or liability for any circumstance involving the misuse, improper installation and/or application of this product.

WARRANTY STATEMENT

Our warranty covers any defect in material or workmanship to the original purchaser for one year after purchase date. We reserve the option to repair or replace the defective unit. Defective product should be packaged in the original carton and packing materials. Include in the package a copy of the sales receipt or other evidence of date of original purchase. Print your name and address, along with a description of the defect, and include this in the package. Include payment for any service not covered by warranty as determined by BrakeAway Products Inc., ship via. UPS Insured or equivalent. All returns require prior Return Authorization, contact us on the web at www.brakeawayproducts.com

**BrakeAway Products Inc.
4191 SE Witch Hazel Rd
Hillsboro, OR 97123
(503) 372-9346**

BrakeAway Products Inc. assumes no responsibility for units sent without prior Return Authorization.

Warranty does not cover:

- * Damage from misuse, neglect, lack of maintenance, accident, improper or careless installation.
- * Products which have been modified in any way.
- * Products purchased more than 12 months prior to the current date.

Returns, Exchanges, & Refunds for Internet Orders:

* All returns/exchanges/refunds **must** be approved by www.brakeawayproducts.com customer service. A return /exchange /refund authorization will be issued to those with approval, and this Return Authorization number must be written on the outside of the package. All return / exchange/ refund claims **must be made within fourteen (14) days of the customer receiving the order, and approved items must be received by BrakeAway Products, Inc., within thirty (30) days of the customer receiving the order**, or return / refund will be refused, and no refund / exchange / return will be issued. All return / exchanges / refunds not due to a shipping or selling error of BrakeAway Products, Inc. are subject to a nonrefundable 15% restocking fee.

Returns, Exchanges & Refunds for Retail Purchases:

- * Refer to individual store policy

Patent No. US 6,820,710 B2

NOTICE ! All Contents and Information contained in this package are Proprietary and shall not be used by any party to reproduce or assist in the reproduction for the distribution of any product identical or similar to the BrakeAway Motorcycle Cruise Control in any way.