



Congratulations on the purchase of your new BrakeAway Motorcycle Cruise Control. At BrakeAway Products, we are committed to your complete satisfaction. With proper installation, use, and periodic maintenance, this cruise control is built for the long haul in more ways than one. Please follow all of the instructions carefully to insure your riding safety and enjoyment.

PROPER USE, AFTER INSTALLATION. (The following information is to be shared with any person who will be riding or buying any Motorcycle equipped with a BrakeAway Cruise Control).

Always include your cruise control in your standard pre-ride inspection. Make sure the unit engages easily, throttle should turn with little effort but remain in position on it's own. The unit should effortlessly snap to the disengaged position with a slight pull of the brake lever or tap of the Manual Release Lever. The throttle should always turn freely when unit is disengaged. Check the Cam(8) (see diagram on next page) for wear at the point of contact with the brake lever or damage of any kind. All fasteners must be tight.

Warning! Never use this product with worn or damaged parts. All replacement parts are obtainable by contacting BrakeAway Products Inc at (503)372-9346 or e-mail customersevice@brakeawayproducts.com.

Once you're on the open road and ready to cruise, reach the speed you want to maintain and let your R.P.M.s level off. While holding the throttle still, reach with your right thumb only and push the engage button(20) until it snaps. Your bike should now maintain your set speed on it's own. You can make adjustments for up or downhill grades with a slight twist of the throttle while engaged.

To disengage the unit simply pull the front brake or push forward on the manual release lever(19) with your right thumb until the unit snaps to the disengaged position. Always keep your cruise control clean and free of debris, occasionally lubricate the catch pin(14) with a light grease or chain wax.

Never forget that you maintain control even when unit is engaged. Always be aware of your cruising speed and maintain safe distance from objects or vehicles in front of you. Never let go of your throttle. The BrakeAway cruise control is not intended for hands free or one handed riding, this unit was specifically designed to allow the rider to safely rest a cramping throttle hand on the throttle.

BrakeAway Products wishes you many years of cramp free cruising, ENJOY!!!

DIAGRAM

1. Slip Ring
2. Set Screws (8-32 X 1/8" SS Set Screw)
3. Clamp Ring Cover
4. Slip Ring
5. Swivel
6. End Bracket
7. Cam
8. Cam Support
9. Cam Screw (8-32 X 1/4 SS Button Head & Lock Washer)
10. Clamp Tension-Adjustment Screws (4-40 X 1/4" SS Pan Head)
11. Tension-Adjustment Hole
12. Spring Plate
13. Catch Pin
14. Swivel Lock Screw (1/4-20 X 1/2" SS socket head cap screw)
15. Slide Lock Screw (8-32 X 1/2" SS Flathead Socket)
16. End Bracket - Lock Screw (10-32 X 3/8" SS Hex Head)
17. Clamp Ring
18. Manual Release Lever
19. Engage Button
20. Cover Screws (2-56 X 1/4" SS Flathead)
21. Adaptor Ring (Stock Grip Only. Specific to Bike Model)
22. Adaptor Ring (Stock Grip Only. Specific to Bike Model)

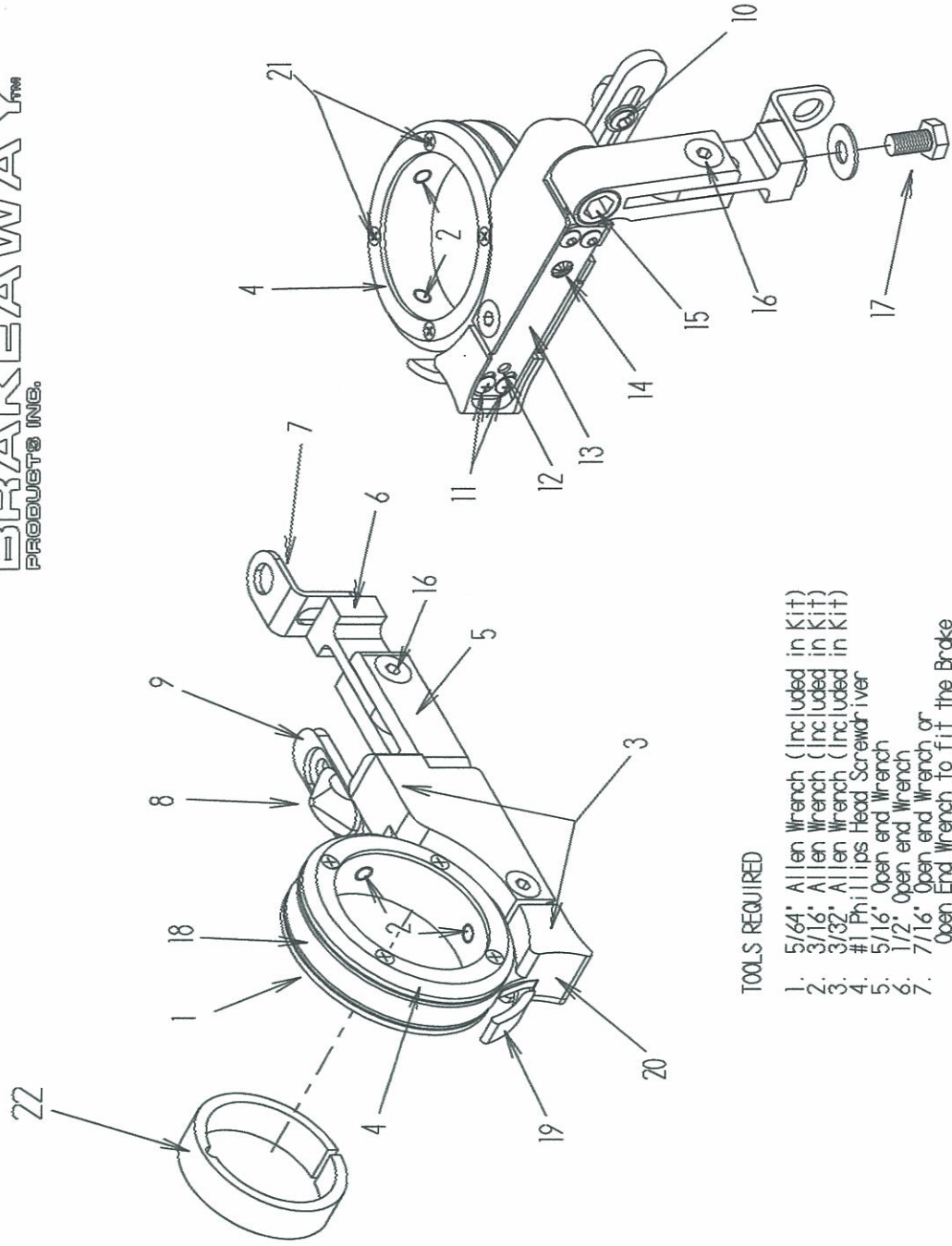

TOOLS REQUIRED

1. 5/64" Allen Wrench (Included in Kit)
2. 3/16" Allen Wrench (Included in Kit)
3. 3/32" Allen Wrench (Included in Kit)
4. #1 Phillips Head Screwdriver
5. 5/16" Open end Wrench
6. 1/2" Open end Wrench
7. 7/16" Open end Wrench or Open End Wrench to fit the Brake Pivot nut of your Motorcycle

BrakeAway Motorcycle Cruise Control Installation Instructions

Before you begin, familiarize yourself with the action of your throttle return spring by turning your throttle and quickly releasing it. This action should not be effected by the installation of this cruise control. Also, correct any excessive play in the brake lever before installation. The brake lever should move no more than 1/4" up or down at the outside end.

Section 1: Slip Ring Attachment

1.1 Remove the four Flathead Screws(21) from the face of the Slip Ring Cover(4) with a small Phillips head screwdriver. Remove the Slip Ring Cover(4) (Figure 1). Push the Slip Ring Collar(1) out of the Cruise Control (Figure 2).



Figure 1

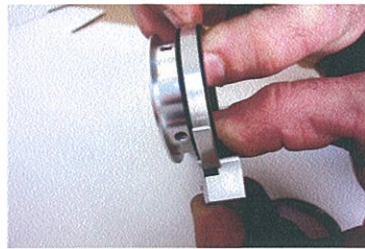

Figure 2



Figure 3

1.2 **Mounting the cruise control to the grip (All models except Yamaha FJR1300)**

Place Adaptor Ring(22) over the grip with the beveled side facing the grip flange (Figures 4 & 5). Slide the Slip Ring(1) over the Adaptor Ring until it is flush against the grip flange. Carefully and equally tighten the four set screws(2), turn each screw 1/2 turn until the slip ring is securely mounted to the grip (Figure 6). Do not exceed 2 full turns or the screws may exit the inside of the ring. Make sure the slip ring (1) runs true and square as you turn the throttle

1.2b **Mounting the cruise control to the throttle tube (Yamaha FJR1300 Only)**

Remove the grip from the plastic throttle tube per manufacturers recommendation. Secure the Adaptor Ring(22) to the throttle tube with a small amount of motorcycle grip adhesive. The Adaptor Ring should be as close to the switch housing as possible without touching it. Place the Slip Ring Collar(1) over the Adaptor Ring. Carefully Tighten the four set screws(2) equally to secure the slip ring (Figure 7). Make sure the slip ring (1) runs true and square as you turn the throttle and that it does not rub on the switch housing. Do Not over tighten the screws or the throttle tube will collapse onto the handlebar and bind your throttle.



Figure 4



Figure 5

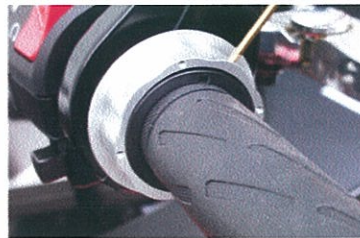

Figure 6



Figure 7 (FJR 1300)

- 1.3 Carefully match the scallop pattern and slip the cruise control assembly over the Slip Ring Collar(1)
Figure 8. Replace the Slip Ring Cover(4) so the screw holes line up and secure the four Flathead screws(21) **Figure 9**

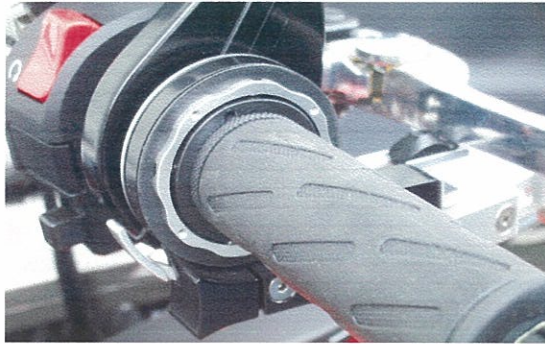

Figure 8



Figure 9

- 1.4 (Yamaha FJR1300 Only) Replace grip per manufacturers instructions. If using glue, poke a hole in a plastic bag and slide it over the throttle tube to create a barrier between the grip and the cruise control. This will help to keep excess glue away from the cruise control. Install the grip and remove the bag quickly by cutting and tearing it away. Before you reinstall the bar end, you will need to add the spacer and longer screw supplied in your kit to compensate for the new grip location.

SECTION 2: CAM ADJUSTMENT

- 2.1 Rotate the Clamp(3) until the Cam Support(9) is positioned directly under the bottom of the motorcycle brake lever. Carefully squeeze the clamp together as shown (Figure 10), until it snaps into the engaged position. **Do not allow the Cam Support(9) to push up against the brake lever or it could bend the Spring Plate(13). Make sure the catch pin(14) is fully engaged into the hole of the spring plate(13) (See Diagram).**
- 2.2 Hold the throttle and the engaged unit so the Cam Support(9) touches the bottom of the brake lever. Slide the Cam(8) against the back of the brake lever. The bill of the Cam should slide under the brake lever. Tighten the Cam Screw(10) (Figure 11). Do not over tighten or you may strip the threads in the cam.

IMPORTANT!!!, MAKE SURE THE LOCK WASHER IS IN PLACE ON THE CAM SCREW (10) AND THE SCREW IS SECURE, AN UNSECURED CAM COULD CAUSE THE BRAKE RELEASE TO MALFUNCTION. DO NOT ride your motorcycle with the Cam(8) out of adjustment. The BrakeAway cruise control is designed to release the instant you tap your brake, before braking actually takes place.

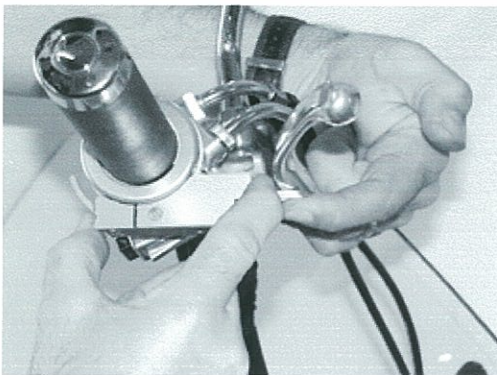

Figure 10

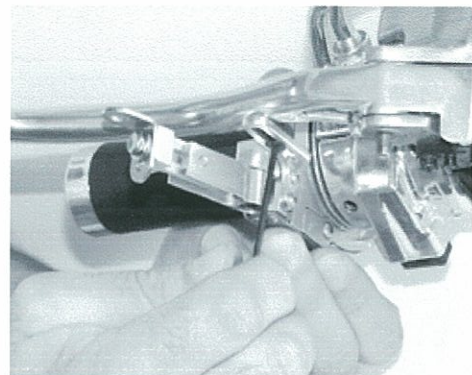

Figure 11

Some details in the figures shown may vary slightly from the most recent design

SECTION 3: SECURING THE ASSEMBLY

- 3.1** Remove the lock nut from the motorcycles brake pivot bolt. Attach the End Bracket(7) and replace the brake pivot lock nut. Apply pressure to the Swivel(5) with your left thumb while tightening the nut with your right hand as shown. **(Figure 12)** This will keep the End Bracket(7) from turning while tightening the brake pivot nut. *(Tighten the nut to manufacturers specifications)*

Note: *If the End Bracket(7) will not reach your brake pivot bolt, you may need to move your brake lever mount closer to the switch housing. There is also an Extension Block and longer End Bracket Screw(17) supplied in your kit. The Extension block is a ½" aluminum cube with a hole thru it, use this to extend the Slide(6).*

- 3.2** Release the cruise control to the off position by pushing the Manual Release Lever(19) forward. **(Figure 13)**

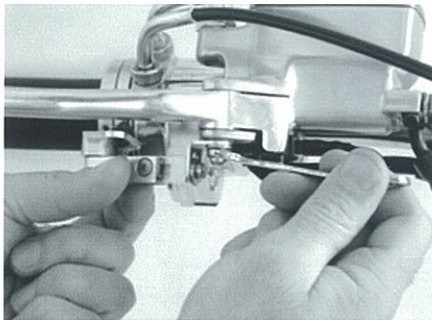

Figure 12

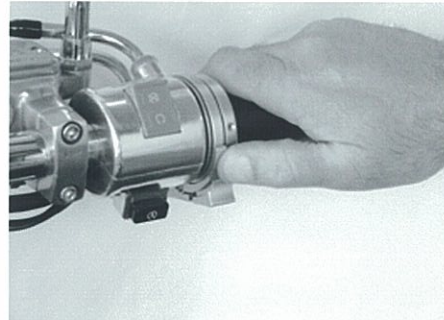

Figure 13

IMPORTANT NOTE! Make sure the cruise control clears your tank!

Before you continue, very slowly and carefully turn your front wheel all the way to the right. Watch the entire cruise control including the end bracket. Make sure that no part of the cruise control can make contact with your paint.

- 3.3** **(It is very important that the clamp remains open or released during this step)**

Pull the brake lever as to engage the front brake and hold it. *Raise or lower the Cam height by sliding the End Bracket Lock Screw(17) up or down in the slot provided.* Position the top of the Cam(8) so it just touches the Bottom of the brake lever **(Figure 14)**, stop as soon as the Cam(8) touches and hold it there. Release the brake lever and **slightly snug** the End Bracket Lock Screw(17) just enough to hold this position. **(Do Not tighten until step 3.5)**

- 3.4** Tighten the Swivel Lock Screw(15). Hold the Clamp(3) to keep the Clamp Ring(18) centered and straight in the groove of the Slip Ring(1) while securing this screw. **(Figure 15).**

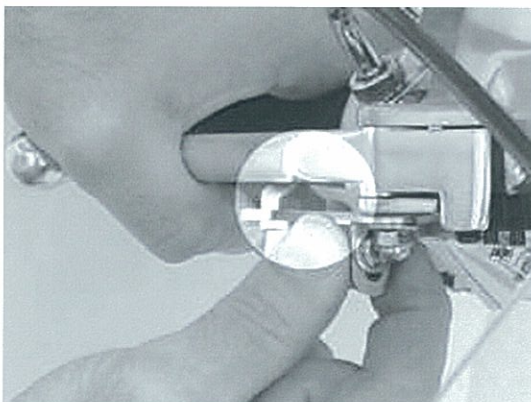

Figure 14



Figure 15

- 3.5 Place a 1/2" open end wrench on the square block end of the Slide(6) (**Figure 16**) to keep the slide from turning as you tighten the End Bracket Lock Screw(17). After tightening the screw, pull your brake lever to check for clearance. The brake lever should just touch the top of the Cam(8) and completely clear the back of the Clamp(3).

NOTE: *If the top of the Cam(8) is too low to achieve the position described above or If your Contoured brake lever does not clear the Clamp at this position, you will need to add the Cam Riser and longer Cam Screw(10) supplied in your kit. The cam riser is a small black oval shaped plastic piece 3/32" thick that will snap on to the bottom of the Cam(8) to raise it. You will find the Cam Riser and longer screw in your wrench bag supplied in your kit. **To add the Riser;** remove the brake pivot nut, loosen the Swivel Lock Screw(15) and move the Swivel to access and remove the Cam Screw(10) and the Cam(8). Snap the **slotted side** of the cam riser on to the bottom of the Cam(8) and reinstall it on the Cam Support(9) using the longer Cam Screw(10) supplied. Re-adjust the Cam(8) position as described in section 2.2. and the Cam(8) height as described in this section 3.3)*

IMPORTANT! Use only the cam riser to raise the cam. Using other objects such as washers to raise the cam could allow the cam to work loose resulting in brake release failure.

- 3.6 Check the operation of the throttle return at this time. It should return normally with no restrictions. Engage and disengage the cruise control 3 or 4 times by squeezing the Clamp together as shown (**Figure 17**) and then releasing it with the Manual Release Lever(19). Adjust the position of the Clamp Ring(18) until it is aligned and centered in the groove of the Slip Ring(1). Check the throttle return again, it should return normally without restriction.

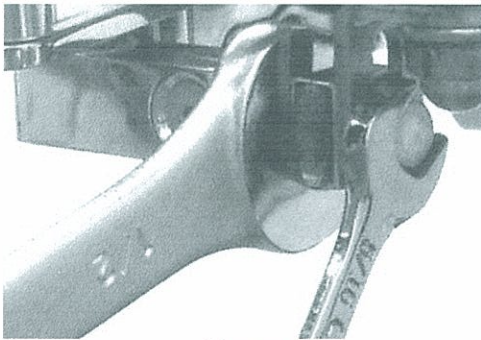

Figure 16

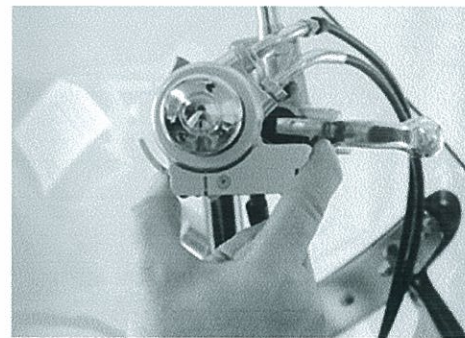

Figure 17

- 3.7 Tighten the Slide Lock Screw(16)(**Figure 18**). Make sure the Swivel(5) and the Slide(6) stay in position as you tighten the screw.
- 3.8 Turn the throttle and engage the cruise control by pushing forward on the Engage Button(20) (**Figure 19**) The hole in the Spring Plate(13) should easily snap to full engagement with the Catch Pin(14). Be careful not to touch the Manual Release Lever(19) while engaging the cruise control.

Turn the throttle back and fourth a few times with the cruise control engaged, throttle should turn with moderate resistance and stay in position when you let go of it.

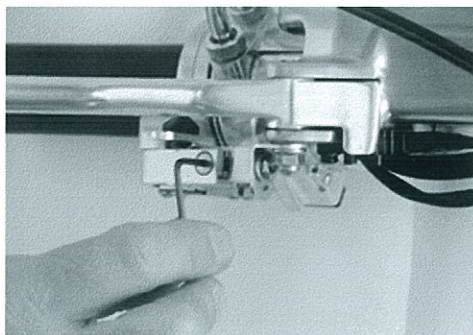

Figure 18

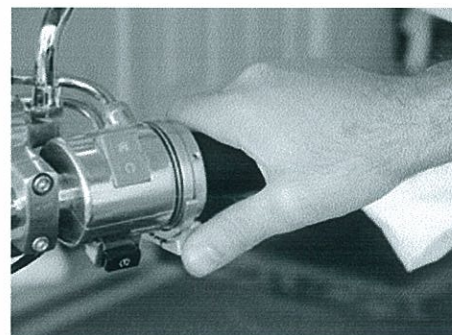

Figure 19

IMPORTANT NOTE !!!

The Cam(8) or the Cam Support(9) should not make contact with the brake lever during engagement. This will interfere with the unit becoming fully engaged. The Cam Support(9) should rest just under the brake lever. The Cam(8) should rest just behind the brake lever at full engagement.

If the engagement is hard and nothing is hitting the brake lever, reposition the clamp slightly toward the back of the bike. This will give the push button(20) some movement and help the hole in the spring plate reach the catch pin with less effort.

- 3.9** Engage the cruise control and check the space between the Cam(8) and the brake lever. The space should not exceed 1/16". Pull the front brake lever, this should push down on the Cam(8) and release your cruise control easily and quickly without binding or hesitation. The brake lever should clear the Clamp(3) even if you push down on it. The brake lever should release the cruise control even if you pull up on it.

Warning! If the brake lever is sharp where it makes contact with the Cam it may cut into the Cam causing the brake release to malfunction. If you experience this problem you will need to file a small radius on the bottom of your brake lever at the contact point of the cam. If you do not wish to file your brake lever, you may return the otherwise undamaged unit to BrakeAway Products for a full refund. DO NOT use this product without correcting this condition.

- 3.10** With the cruise control in the off position check the throttle return, it should return normally with no hesitation or bind. Binding of the throttle is usually caused by something in the installation being twisted or misaligned. The goal is to Have the disengaged Clamp(3) suspended loosely around the Slip Ring(1) when everything is tight. **If the throttle return binds, even slightly** follow the troubleshooting guide below.

Troubleshoot binding in this order until throttle snaps back:

1. **Gently, slowly and very slightly** turn the Slide(6) with a 1/2" open end wrench, clockwise first then counter clockwise while checking the throttle return. Try to find a position where the throttle returns freely. If this works, then hold the Slide(5) with the 1/2" open end wrench and retighten the End Bracket Lock Screw(17).
2. Loosen the Slide Lock Screw(16). With this screw loose, the Swivel(5) should move freely on the Slide(6). If it doesn't, then turn the Slide(6) with a 1/2" open end wrench until the two pieces are not in a bind. Reposition the Clamp Ring (18) so it is straight and centered in the groove in the Slip Ring(1). Retighten the Slide Lock Screw(16).
3. Loosen and retighten the Brake Pivot Nut. Hold the cruise control from turning when you tighten the nut.
4. Loosen the Swivel Lock Screw(15) and the Slide Lock Screw(16). Hold the clamp(3) so the Clamp Ring(18) remains straight and in the center of the groove in the slip ring while you retighten the Swivel Lock Screw(15). Retighten the Slide Lock Screw(16).

- 3.11 Double check the Brake Pivot nut, Swivel Lock Screw(15), End Bracket Lock Screw(17) and the Slide Lock Screw(16) to make sure they are secure and tight.**

If you are unable to eliminate binding of the throttle, contact BrakeAway Products tech support for assistance (503) 372-9346 or email techsupport@brakeawayproducts.com

SECTION 4: CLAMP TENSION ADJUSTMENT

Clamp Tension refers to the amount of friction or resistance which is applied to the throttle when the cruise control is engaged. If your cruise control tension is too loose and will not hold reasonable throttle return spring tension, or if the factory setting ends up being too tight, follow these instructions carefully.

- 4.1 With cruise control in the **engaged** position, loosen and very lightly snug the two clamp tension adjustment screws(11) (**See Diagram**). Make sure the catch pin(14) remains fully engaged in the hole in the spring plate(13).
- 4.2 Insert the back side of a small Allen wrench into the tension adjustment hole(12). Pull the bottom of the wrench back in a prying motion, toward the back of the bike (**Figure 20**) to tighten, or push forward to loosen while turning the throttle to test the clamp tension. Stop as soon as the clamp will hold the throttle in place. Throttle should turn smoothly with moderate resistance.
- 4.3 Tighten the two clamp adjustment screws(11).

WARNING!!! NEVER OVER TIGHTEN THE CLAMP TENSION. THIS PRODUCT IS DESIGNED TO RESIST ONLY THE THROTTLE RETURN SPRING TENSION. THE RIDER SHOULD ALWAYS BE ABLE TO EASILY ADJUST THE THROTTLE POSITION. OVER TIGHTENING THE CLAMP COULD CAUSE THE THROTTLE TO BE UNMANAGEABLE AND HAS THE POTENTIAL TO CAUSE BRAKE RELEASE FAILURE.

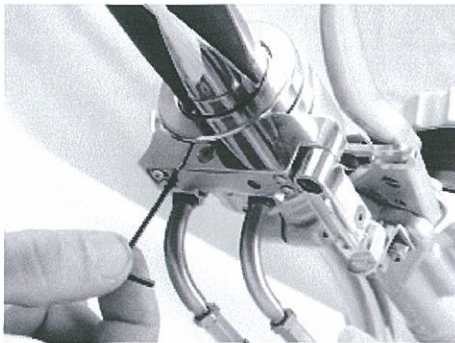
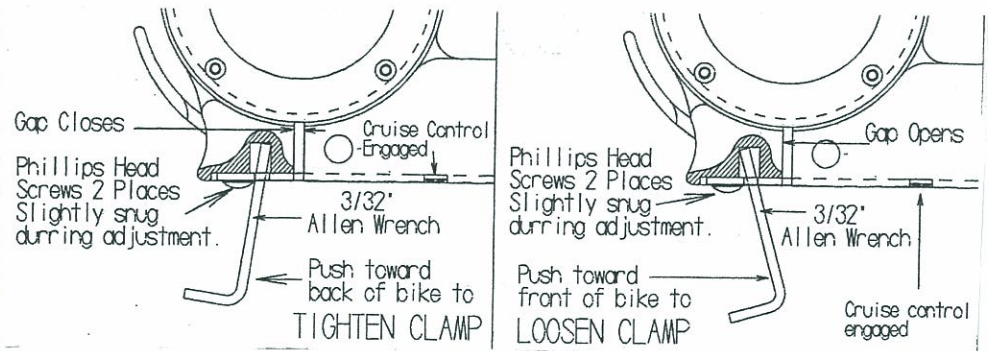

Figure 20



SECTION 5: INSPECTION AND MAINTENANCE

- 5.1 Check your cruise control for proper operation during your pre-ride safety inspection. Make sure all components are tight and functioning properly. Check the Cam(8) for wear or damage of any kind.
- 5.2 Occasionally lubricate the catch pin(14) with chain wax or WD-40; Annually remove the cruise control and wash it Thoroughly with warm soapy water to remove road film and then dry thoroughly and re-lube the catch pin. Inspect the Cam(8) and all other components for wear or damage. Do Not use the BrakeAway Cruise Control with any Worn, loose or damaged parts. All components are obtainable from BrakeAway Products Inc. (503)372-9346 or e-mail customerservice@brakeawayproducts.com

Trouble shooting

1. **Problem: Throttle is binding with cruise control disengaged.**

Cause: The Clamp(3) is positioned incorrectly so it is rubbing on the slip ring.

Solution: With cruise control disengaged, Please follow the instructions below in order until your throttle returns freely.

- A. **Gently, slowly and very slightly** turn the Slide(6) with a 1/2" open end wrench, clockwise first then counter clockwise while checking the throttle return. Try to find a position where the throttle returns freely. If this works, then hold the Slide(6) with the 1/2" open end wrench and retighten the End Bracket Lock Screw(17).
- B. Loosen the Swivel Lock Screw(15) and the Slide Lock Screw(16). Hold the clamp(3) so the Clamp Ring(18) remains straight and in the center of the groove in the slip ring while you retighten the Swivel Lock Screw(15). retighten the Slide Lock Screw(16).
- C. Loosen and retighten the Brake Pivot Nut. Hold the cruise control from turning when you tighten the nut.

2. **Problem: Cruise control is hard to engage**

Cause: The Clamp(3) is probably positioned too far forward (toward the front of the bike) Usually happens because the end bracket(7) turns when the brake pivot nut is tightened (section 3.1)

Solution: Reposition the clamp slightly toward the back of the bike. *This will free up some movement or travel in the push button(20). To do this, slowly turn the brake pivot nut as if to loosen it, watch the Clamp(3) as you turn the nut, at some point it should move toward the back of the bike. Stop as soon as you see it move. Retighten the brake pivot nut while holding the Clamp from moving forward. your cruise control should now engage easily.*

3. **Problem: Cruise control will not stay engaged**

Cause: The hole in the Spring Plate(13) is not fully engaging onto the Catch Pin(14)

There are three reasons why this might happen, see A,B,C respectively:

Reason A: The Cam(8) or the Cam Support(9) is hitting the brake lever during engagement.

Solution A: Readjust the Cam position or Cam height so it does not make contact the brake lever during engagement. See section 2.2 or 3.3.

Reason B: The Clamp Tension is too tight. Your throttle should not be hard to move with cruise control engaged.

Solution B: See section 4 to readjust the Clamp tension

Reason C: The Spring Plate has been bent down away from the Catch Pin.

Solution C: Remove the two Clamp Tension Adjustment Screws(11). The Spring Plate, Cam Support and Cam will come down as an assembly. Place the slotted end of the Spring Plate about 5/8" down in a bench vise with the Cam support pointing straight up. The serial number should be facing you. Now push on the spring plate until you feel it bend just slightly, Approximately 2 degrees past flat. Reinstall the Spring Plate and readjust the Clamp Tension as described in section 5. If the cruise control is hard to release then the plate is bent too much.

Please contact BrakeAway Products tech support for additional assistance @ (503) 372-9346 or email techsupport@brakeawayproducts.com

“WARNING !!!”

These instructions were designed as a guide line to install the BrakeAway Cruise Control. BrakeAway Products, Inc. assumes no responsibility for the competence level of the installer or the ability of the installer to determine the proper function of the BrakeAway Cruise Control. Proper installation, maintenance, and pre-ride inspection are essential to the safety of the BrakeAway Cruise Control, and are the sole responsibility of the installer and or user of the BrakeAway Cruise Control. If the installer and or user of the BrakeAway Cruise Control is unable to achieve function satisfactory to the user, or if the user is unable to maintain satisfactory function of the BrakeAway Cruise Control, it is the responsibility of the user to remove it or have it removed. You may return it to BrakeAway Products, Inc. under the terms of the warranty, within the warranty period.

Serious injury or death could result if the BrakeAway Cruise Control is installed improperly and or used irresponsibly. Hands free or one handed operation of a motorcycle is considered by BrakeAway Products Inc. to be dangerous and irresponsible and is not the intended function of this product.

Do Not install this product on any motorcycle which has not been tested and listed exclusively by BrakeAway Products Inc. for proper fit. See fit list on the back of package or at www.brakeawayproducts.com
BrakeAway Products, Inc. assumes no liability for the misuse, improper installation or application of this product.

WARRANTY STATEMENT

Our warranty covers any defect in material or workmanship to the original purchaser for one year after purchase date. We reserve the option to repair or replace the defective unit. Defective product should be packaged in the original carton and packing materials. Include in the package a copy of the sales receipt or other evidence of date of original purchase. Print your name and address, along with a description of the defect, and include this in the package. Include payment for any service not covered by warranty as determined by BrakeAway Products Inc., ship via. UPS Insured or equivalent. All returns require prior Return Authorization, contact us on the web at www.brakeawayproducts.com

BrakeAway Products Inc.
4191 SE Witch Hazel Rd
Hillsboro, OR 97123
(503) 372-9346

BrakeAway Products Inc. assumes no responsibility for units sent without prior Return Authorization.

Warranty does not cover:

- * Damage from misuse, neglect, lack of maintenance, accident, improper or careless installation.
- * Products which have been modified in any way.
- * Products purchased more than 12 months prior to the current date.

Returns, Exchanges, & Refunds for Internet Orders:

* All returns/exchanges/refunds **must** be approved by www.brakeawayproducts.com customer service. A return /exchange /refund authorization will be issued to those with approval, and this Return Authorization number must be written on the outside of the package. All return / exchange/ refund claims **must be made within fourteen (14) days of the customer receiving the order, and approved items must be received by BrakeAway Products, Inc., within thirty (30) days of the customer receiving the order**, or return / refund will be refused, and no refund / exchange / return will be issued. All return / exchanges / refunds not due to a shipping or selling error of BrakeAway Products, Inc. are subject to a nonrefundable 15% restocking fee.

Returns, Exchanges & Refunds for Retail Purchases:

- * Refer to individual store policy

Patent No. US 6,820,710 B2

NOTICE ! All Contents and Information contained in this package are Proprietary and shall not be used by any party to reproduce or assist in the reproduction for the distribution of any product identical or similar to the BrakeAway Motorcycle Cruise Control in any way.